

# MEGAPIX<sup>®</sup> IVA<sup>™</sup>

IP cameras with Intelligent Video Analytics

- DWC-MHS5W37T - preloaded with IVA engine
- DWC-MPH55W37T - preloaded with IVA+ engine

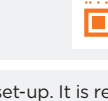
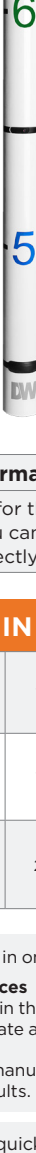

### Default login information: admin | admin

When logging into the camera for the first time, you will be prompted to set up a new password. You can set the new password using the DW<sup>®</sup> IP Finder<sup>™</sup> software or directly from the camera's browser menu.

## WHAT'S IN THE BOX

Hexagonal Wrench (HEX 2.5mm)		1	Quick Setup and Download Guides		1 set
DC Plug Cable		1	Screws and Plastic Anchors		4
Lens hole plug		2			

**NOTE:** Download all your support materials and tools in one place

- Go to: <http://www.digital-watchdog.com/resources>
- Search your product by entering the part number in the 'Search by Product' search bar. Results for applicable part numbers will populate automatically based on the part number you enter.
- Click 'Search'. All supported materials, including manuals and quick start guide (QSGs) will appear in the results.

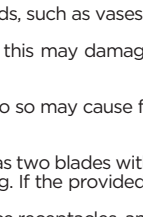

**Attention:** This document is intended to serve as a quick reference for the initial set-up. It is recommended that the user read the entire instruction manual for complete and proper installation and usage.

## SAFETY AND WARNING INFORMATION

Read through this Installation Guide carefully before installing the product. Keep the Installation Guide for future reference. See the user manual for more information on the proper installation, use and care of the product. These instructions are intended to ensure that users can use the product correctly to avoid danger or property loss. Warnings: Serious injury or death may occur if any of the warnings are neglected. Caution: Injury or equipment damage may occur if any of the cautions are neglected.

### WARNING

- In the use of the product, you must be strict compliance with the electrical safety regulations of the nation and region. When the product is mounted on a wall or ceiling, the device shall be firmly fixed.
- Do not drop objects on the product or apply strong shock to it. Keep away from a location subject to excessive vibration or magnetic interference.
- Do not use this product near water.
- The product shall not be exposed to dripping or splashing and no objects filled with liquids, such as vases, shall be placed on the product.
- Avoid aiming the camera directly towards extremely bright objects such as the sun, as this may damage the image sensor.
- Securely plug the power cord into the power source. An insecure connection may cause a fire.
- When installing the camera, fasten it securely and firmly. A falling camera may cause personal injury.
- Do not install in a location subject to elevated temperature, low temperature, or high humidity. Doing so may cause fire or electric shock.
- Do not place conductive objects (e.g. screwdrivers, coins, metal items, etc.) or containers filled with water on top of the camera. Doing so may cause personal injury due to fire, electric shock, or falling objects.
- Do not install in humid, dusty, or sooty locations. Doing so may cause fire or electric shock.
- Do not install near any heat sources such as radiators, heat registers, or other products (including amplifiers) that produce heat.
- If any unusual smells or smoke come from the unit, stop using the product at once. Immediately disconnect the power source and contact the service center. Continued use in such a condition may cause fire or electric shock.
- If this product does not operate normally, contact the nearest service center. Never disassemble or change the product in any way.
- When cleaning the product, do not spray water directly onto parts of the product. Doing so may cause fire or electric shock.

### CAUTION

- Use proper safety gear when installing and wiring the product.
- Do not drop objects on the product or apply strong shock to it. Keep away from a location subject to excessive vibration or magnetic interference.
- Do not use this product near water.
- The product shall not be exposed to dripping or splashing and no objects filled with liquids, such as vases, shall be placed on the product.
- Avoid aiming the camera directly towards extremely bright objects such as the sun, as this may damage the image sensor.
- Securely plug the power cord into the power source. An insecure connection may cause a fire.
- When installing the camera, fasten it securely and firmly. A falling camera may cause personal injury.
- Do not install in a location subject to elevated temperature, low temperature, or high humidity. Doing so may cause fire or electric shock.
- Do not place conductive objects (e.g. screwdrivers, coins, metal items, etc.) or containers filled with water on top of the camera. Doing so may cause personal injury due to fire, electric shock, or falling objects.
- Do not install in humid, dusty, or sooty locations. Doing so may cause fire or electric shock.
- Do not install near any heat sources such as radiators, heat registers, or other products (including amplifiers) that produce heat.
- If any unusual smells or smoke come from the unit, stop using the product at once. Immediately disconnect the power source and contact the service center. Continued use in such a condition may cause fire or electric shock.
- If this product does not operate normally, contact the nearest service center. Never disassemble or change the product in any way.
- When cleaning the product, do not spray water directly onto parts of the product. Doing so may cause fire or electric shock.

- Use only attachments/accessories specified by the manufacturer.
- Always use hardware (e.g. screws, anchors, bolts, locking nuts, etc.) compatible with the mounting surface and of sufficient length and construction to ensure a secure mount.
- Use only with cart, stand, tripod, bracket, or table specified by the manufacturer, or sold with the product. Unplug this product when a cart is used. Use caution when moving the cart/product combination to avoid injury from tip-over.
- Refer all servicing to qualified service personnel. Servicing is needed when the product has been damaged in any way, such as power supply cord or plug is damaged, liquid has been spilled or objects have fallen into the product, the product has been exposed to rain or moisture, does not operate normally, or has been dropped.

## STEP 1 – PREPARING THE CAMERA

- For the installation process, remove the four (4) fixed screws on the side of the camera and remove the top cover. Use a Phillips screwdriver (not included).
- Using the camera itself, mark and drill the necessary holes in the wall by the door being monitored. The camera requires four (4) mounting holes and an additional hold for the cable. The camera should be mounted at 4.3feet (approximately 1.3 meter) between the bottom of the camera and the floor.

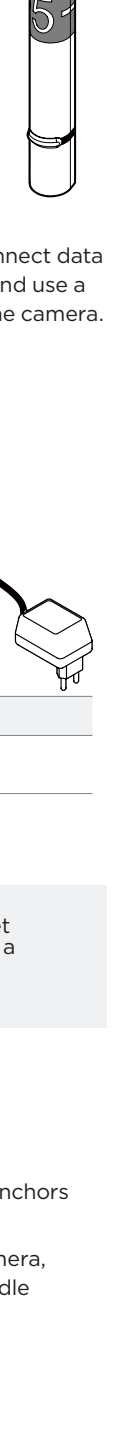
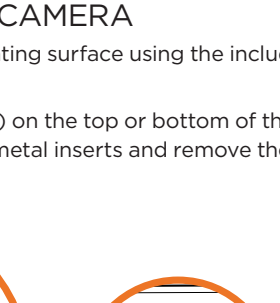

## STEP 2 – POWERING THE CAMERA

Pass the wires through and make all necessary connections.

Use a PoE Injector (required. Sold separately) to connect data and power to the camera using a single Ethernet cable.

Use non-PoE Switch to connect data using and Ethernet cable and use a power adapter to power the camera.

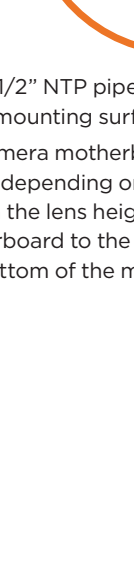

OR

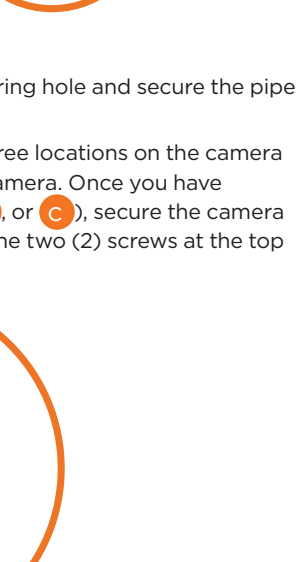

Power requirements	Power consumption
DC12V, PoE IEEE 802.3af Class2 (Adapter not included)	1A adapter is recommended DC12V Max 4W, PoE Max 4.8W

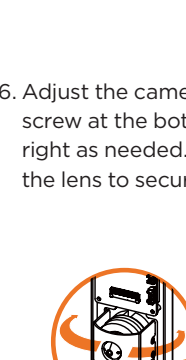

**Reset Button** **Resetting the camera:** Press the reset button for five (5) seconds to initiate a camera-wide reset of all the settings, including network settings.

## STEP 3 – INSTALLING THE CAMERA

- Attach the camera base to the mounting surface using the included anchors and screws.
- To use the wiring pipe hole (optional) on the top or bottom of the camera, use metal clips to cut the two small metal inserts and remove the middle knockout plug.

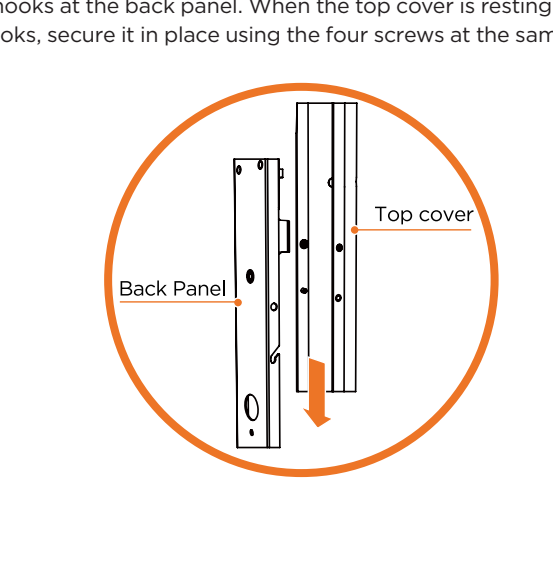

- Pass a 1/2" NTP pipe through the newly made wiring hole and secure the pipe to the mounting surface.
- The camera motherboard can be mounted on three locations on the camera based, depending on the desired height of the camera. Once you have chosen the lens height from the options (a, b, or c), secure the camera motherboard to the camera base by tightening the two (2) screws at the top and bottom of the motherboard. Use a .

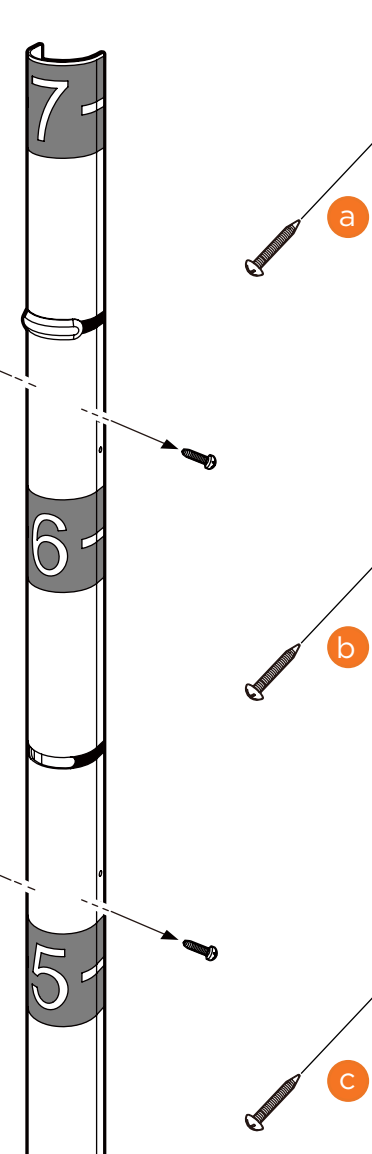

- Using the lens blocks included, cover the two remaining lens windows in the camera cover.
- Adjust the camera's lens positions using the hexagonal wrench. Loosen the screw at the bottom of the camera lens. Move the camera lens gently left or right as needed. The max tilting angle is 20°. Tighten the screw at the top of the lens to secure the camera modules' position.

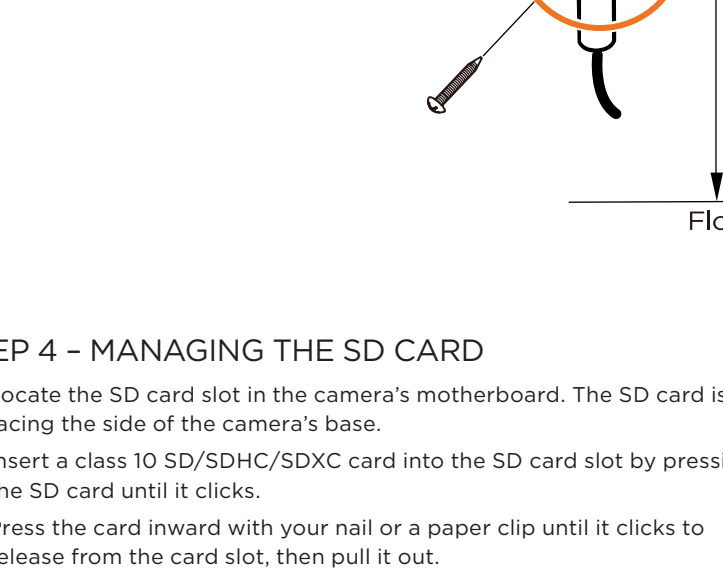

- Assembling the top cover over the camera body. Slide the top cover over the locking hooks at the back panel. When the top cover is resting on the back panel hooks, secure it in place using the four screws at the same if the top cover.

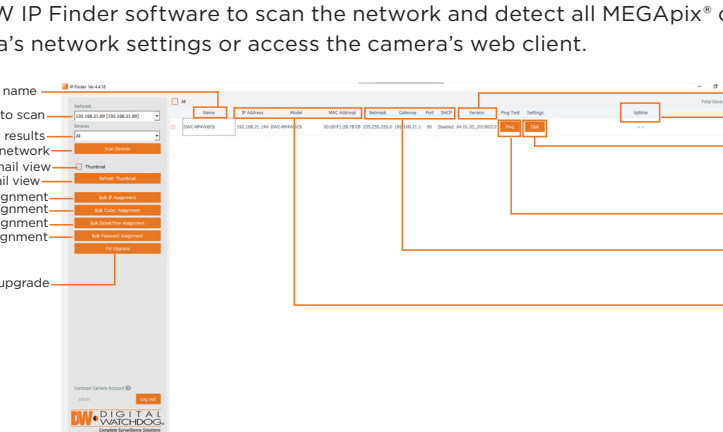
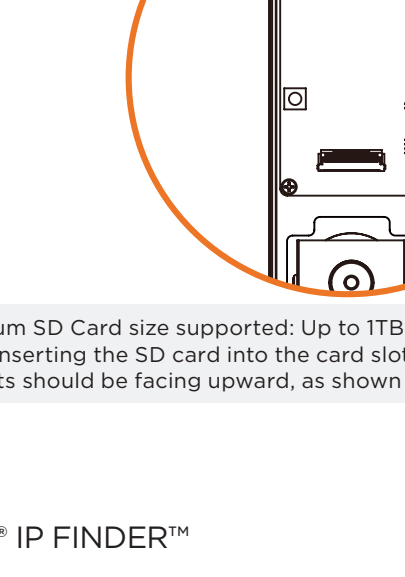

## STEP 4 – MANAGING THE SD CARD

- Locate the SD card slot in the camera's motherboard. The SD card is facing the side of the camera's base.
- Insert a class 10 SD/SDHC/SDXC card into the SD card slot by pressing the SD card until it clicks.
- Press the card inward with your nail or a paper clip until it clicks to release from the card slot, then pull it out.

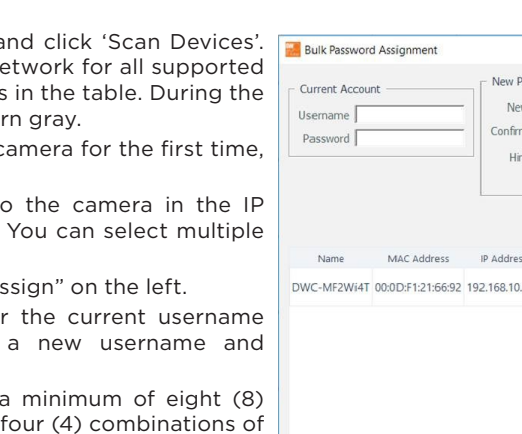

**NOTE:** Maximum SD Card size supported: Up to 1TB micro SD / FAT32. When inserting the SD card into the card slot, the SD card's contacts should be facing upward, as shown in the diagram.

## STEP 5 – DW<sup>®</sup> IP FINDER<sup>™</sup>

Use the DW IP Finder software to scan the network and detect all MEGAPIX<sup>®</sup> cameras, set the camera's network settings or access the camera's web client.



### Network Setup

- To install the DW IP Finder, go to: <http://www.digital-watchdog.com>
- Enter "DW IP Finder" on the search box at the top of the page.
- Go to the "Software" tab on the DW IP Finder page to download and install the installation file.
- Open the DW IP Finder and click "All Devices". It will scan the selected network for all supported devices and list the results in a table. During the scan, the DW<sup>®</sup> logo will turn gray.
- When connecting to the camera for the first time, a password must be set.
  - Check the box next to the camera in the IP Finder's search results. You can select multiple cameras.
  - Click "Bulk Password Assign" on the left.
  - Enter admin/admin for the current username and password. Enter a new username and password to the right. Passwords must have a minimum of eight (8) characters and at least four (4) combinations of uppercase letters, lowercase letters, numbers and special characters. Passwords cannot contain the user ID.
  - Click "change" to apply all changes.
- Select a camera from the list by double-clicking on the camera's name and the 'Click' button. The pop-up window will show the camera's current network settings. Admin users can adjust the settings as needed. The camera's network settings are set to DHCP by default.
- To access the camera's web page, click on the 'Website' button.
- To save changes made to the camera's settings, enter the username and password of the camera's admin account and click 'Apply'.

- Select 'DHCP' for the camera to automatically receive its IP address from the DHCP server.
- Select 'Static' to manually enter the camera's IP address, (Sub) Netmask, Gateway and DNS information.
- The camera's IP must be set to static if connecting to Spectrum<sup>®</sup> IPVMS.
- Contact your network administrator for more information.

- To access the camera from an external network, port forwarding must be set in your network's router.

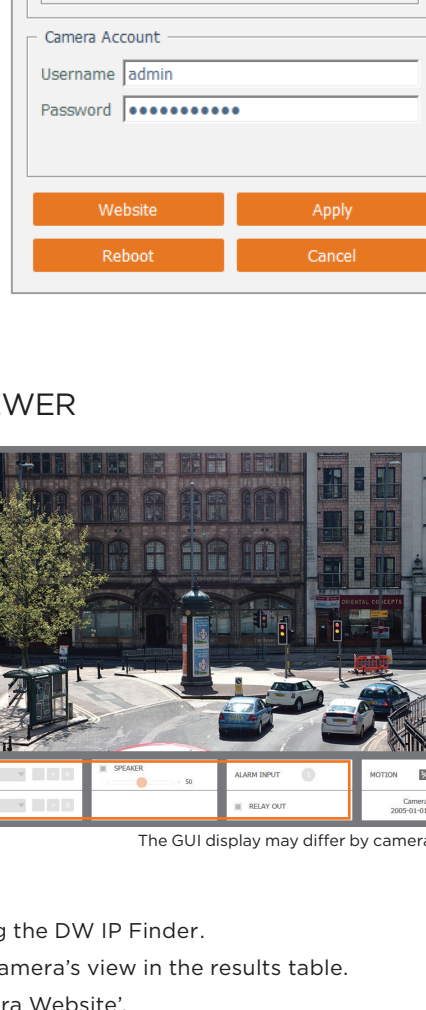

## STEP 6 – WEB VIEWER

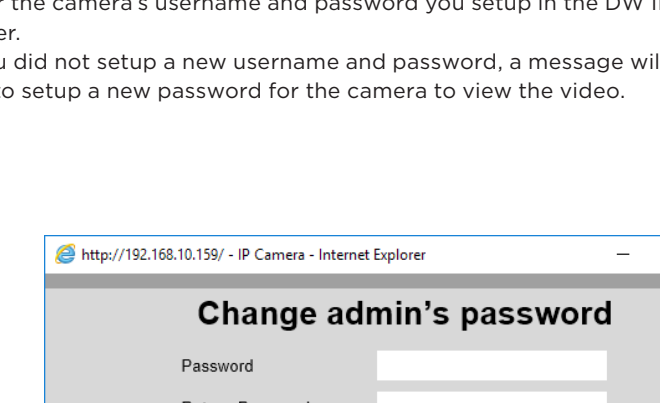

- Find the camera using the DW IP Finder.
- Double-click on the camera's view in the results table.
- Press the 'View Camera Website'.
- Enter the camera's username and password you setup in the DW IP Finder. If you did not setup a new username and password, a message will direct you to setup a new password for the camera to view the video.

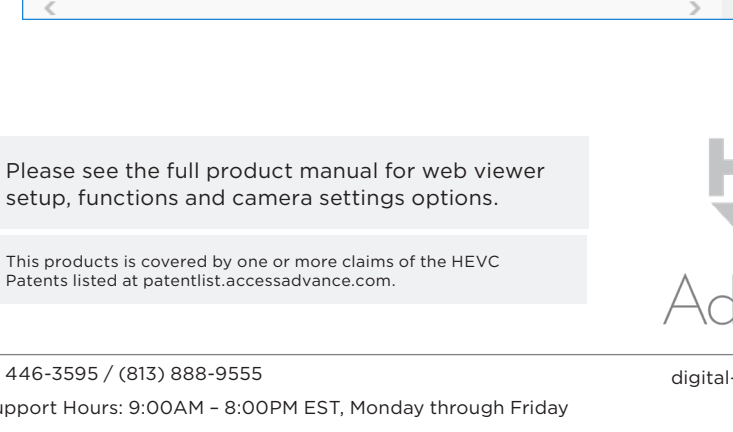

**NOTE:** Please see the full product manual for web viewer setup, functions and camera settings options.

**NOTE:** This products is covered by one or more claims of the HEVC Patent listed at [patentist.accessadvance.com](http://patentist.accessadvance.com).

